

# Sicmol

KNOW OUR PRODUCTS

# THE COMPANY

Sicmol S.A. is an industry with know-how and advanced technology in the manufacture of bathroom furniture and accessories. It is located in Aparecida de Goiânia-Goiás-Brazil and present on the market since 1988.

Its origin is the traditional business group Sebba, founded in 1958, well known for its performance in the trade of construction materials, furniture manufacturing and exporting of wood.

Nowadays, the industry has diversified line of products, ready to attend the consumer's varied demands of furnitures, accessories and tiles.



*CLICK ON THE DESIRED  
CATEGORY TO BE DIRECTED*



04 TOILET SEATS

17 BATH ACCESSIBLE LINE

21 BATHROOM ACCESSORIES

33 BATHROOM VANITIES

43 WASHBASINS



## TOILET SEATS

# SOFISTICATO SOFT CLOSE

CODE	MODEL
25647	BOSS
25644	CONVENCIONAL
25645	CARRARA/NUOVA/DUNA/LINK/LK/LEVEL/OMEGA/HAPPENING/VESUVIO/ESTORIL
25646	RIVIERA/NEXO/SMART/NEO



UNIT PACK



MASTER PACK

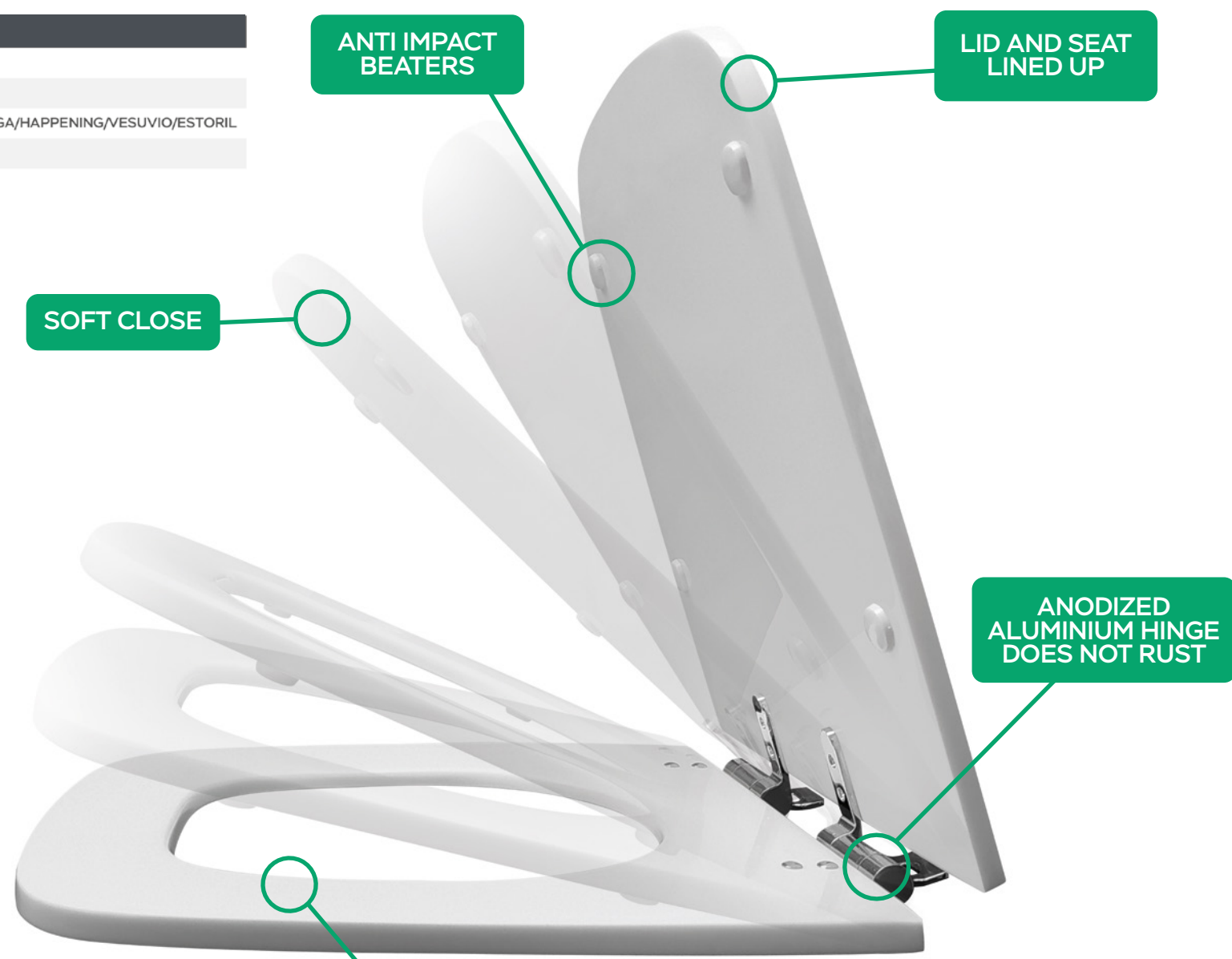
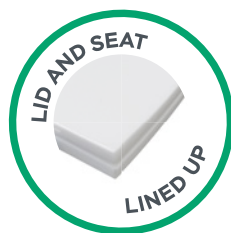
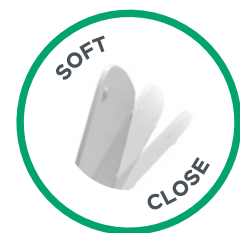

CURVED SEAT FOR A BETTER COMFORT

### COLORS



**Sicmol**  
THE BEST TOILET SEAT

## CHARACTERISTICS

- MODERN DESIGN.
- EASY TO CLEAN.
- 100% WATERPROOF.
- HIGH GLOW.
- EASY INSTALLATION.
- INSTALLATION KIT.
- CHROME COVERS THAT HIDE THE SCREWS.

## COMPOSITION

- TOILET SEAT: 100% POLYESTER AND PIGMENTED RESIN.
- CHROMED ZINC HINGE, DOES NOT RUST.

## MASTER PACK

- 5 UNITS.



## TOILET SEATS

# PRIVILÈGE SOFT CLOSE

CODE	MODEL
25638	CONVENCIONAL
25643	CARRARA/NUOVA/DUNA/LINK/LK/LEVEL/OMEGA/HAPPENING/VESUVIO/ESTORIL
25639	MONTE CARLO/TURIM
25641	RIVIERA/NEXO/SMART/NEO
25642	THEMA/HAWAII
25640	VOGUE PLUS/ETNA



UNIT PACK



MASTER PACK

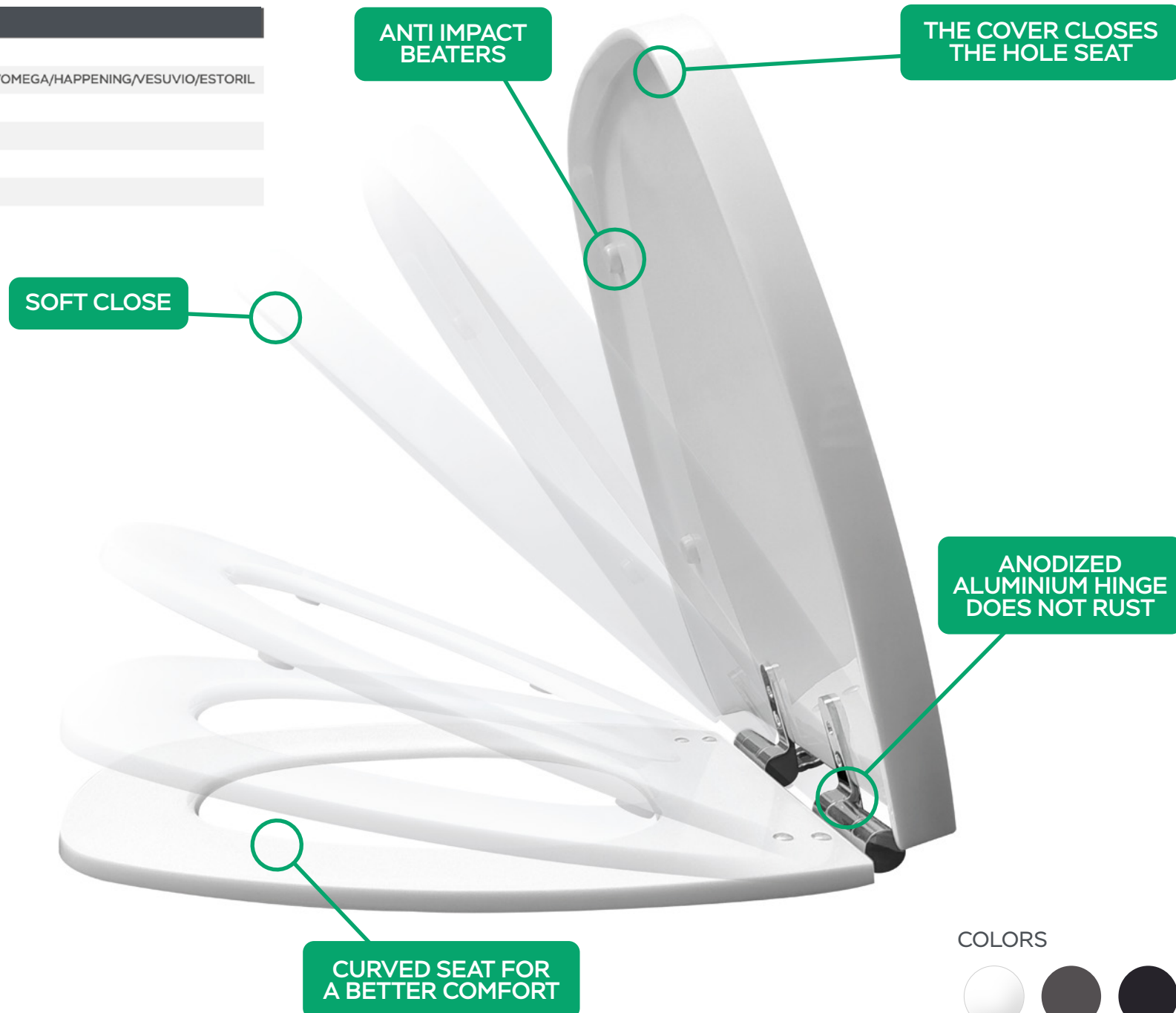
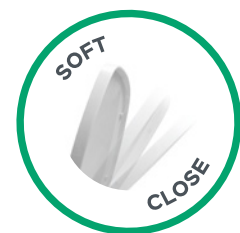

### COLORS



**Sicmol**  
THE BEST TOILET SEAT

## CHARACTERISTICS

- MODERN DESIGN.
- EASY TO CLEAN.
- 100% WATERPROOF.
- HIGH GLOW.
- EASY INSTALLATION.
- INSTALLATION KIT.
- CHROME COVERS THAT HIDE THE SCREWS.

## COMPOSITION

- TOILET SEAT: 100% POLYESTER AND PIGMENTED RESIN.
- CHROMED ZINC HINGE, DOES NOT RUST.

## MASTER PACK

- 5 UNITS.

## TOILET SEATS

# POLYESTER



**Sicmol**  
THE BEST TOILET SEAT



ALSO AVAILABLE FOR ACCESSIBLE BATHROOM



UNIT PACK



MASTER PACK



## CHARACTERISTICS

- HIGH IMPERMEABILITY.
- HIGH GLOW.
- INSTALLATION KIT.
- EASY INSTALLATION.
- MODERN DESIGN.

## COMPOSITION

- TOILET SEAT: 100% POLYESTER AND PIGMENTED RESIN.
- HINGE: ANODIZED ALUMINIUM.

## MASTER PACK

- 3, 5 OR 10 UNITS.

AVAILABLE IN DIFFERENT COLORS AND MODELS.

## MODELS AND COLORS

CODE	MODEL
25622	AMARILIS
15139	ANGRA/AVANT/CITY/CITY PLUS/LIKE/VIP/ART/FLEX
5536	ASPEN/FAST/LOREN ONE/ALAMO
2180	ATRIUM
2182	BALI/HALL
18523	BOSS
2184	CALYPSO
18984	CALYPSO PLUS
2235	CARRARA/NUOVA/DUNA/LINK/LK/LEVEL/OMEGA/HAPPENING/VESUVIO/ESTORIL
2238	CONVENCIONAL
688	CONVENCIONAL PNE SEM TAMPA
15314	CONVENCIONAL PNE COM TAMPA
24025	DEBBA
2241	DUOMO PLUS
26549	ELITE
2242	EROS
25621	FLOX
2244	HAMPTON
2245	IBIZA
25623	LIRIO
2339	MONTE CARLO/TURIM
2341	PARIS/EZEDRA
17405	QUADRA/PIANO/POLO/AXIS/UNIC/GAP/LOREN LIKE
2343	RAVENA/TARGA/IZY/STUDIO
2345	RIVIERA/NEXO/SMART/NEO
2346	SABATINI/DONA BEJA
17849	SPOT
2347	SQUARE
2348	STYLUS/PRIMULA PLUS
2349	STYLUS EXCELLENCE

CODE	MODEL
24026	SUITE
2350	THEMA/HAWAII
2351	TIVOLI
2353	VERSATO/FIT/SAVARY
2354	VICTORIA ABSOLUTE
2355	VILLAGE
2356	VOGUE PLUS/ETNA
15315	VOGUE PLUS/ETNA PNE COM TAMPA
6374	VOGUE PLUS/ETNA PNE SEM TAMPA





## TOILET SEATS

# POLYESTER SLIM

CODE	MODEL
25555	CONVENCIONAL
25561	RAVENA/TARGA/IZY/STUDIO
25564	SABATINI/DONA BEJA



UNIT PACK



MASTER PACK

AVAILABLE ONLY IN WHITE COLOR.



DOUBLE RIVET REINFORCEMENT

ANODIZED ALUMINIUM HINGE DOES NOT RUST



100% POLYESTER

RECTIFIED EDGE

**Sicmol**  
THE BEST TOILET SEAT

## CHARACTERISTICS

- GREAT COST BENEFIT.
- EASY TO CLEAN.
- 100% WATERPROOF.
- HIGH GLOW.
- DOUBLE RIVET REINFORCEMENT.
- INSTALLATION KIT.
- EASY INSTALLATION.
- MODERN DESIGN.

## COMPOSITION

- TOILET SEAT: 100% POLYESTER AND PIGMENTED RESIN.
- HINGE: ANODIZED ALUMINIUM.

## MASTER PACK

- 3, 5 OR 10 UNITS.

## TOILET SEATS

# MDF



ALSO AVAILABLE FOR ACCESSIBLE BATHROOM



UNIT PACK



MASTER PACK

AVAILABLE IN DIFFERENT COLORS AND MODELS.

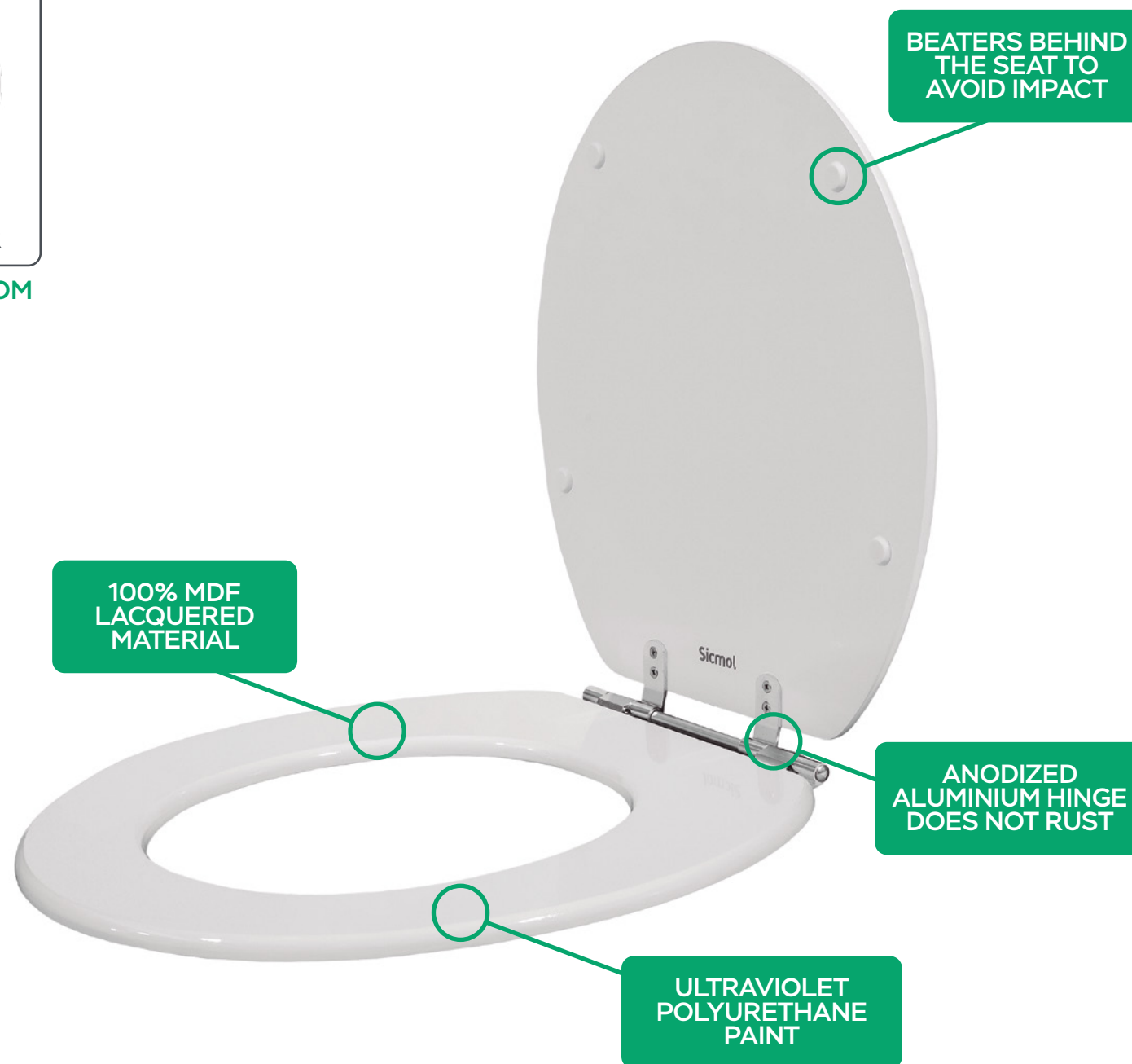

# Sicmol

THE BEST TOILET SEAT

## CHARACTERISTICS

- HINGE FIXATION PERFORMED BEHIND THE COVER WHICH MAKES IT EVEN MORE DIFFICULT FOR WATER ENTRY.
- HIGH IMPERMEABILITY.
- HIGH GLOW .
- INSTALLATION KIT.
- EASY INSTALLATION.
- MODERN DESIGN.

## COMPOSITION

- TOILET SEAT: 100% MDF LACQUERED MATERIAL, ULTRAVIOLET POLYURETHANE PAINT.
- ANODIZED ALUMINIUM HINGE.

## MASTER PACK

- 3, 5 OR 10 UNITS.

## MODELS AND COLORS

CODE	MODEL
25583	AMARILIS
15054	ANGRA/AVANT/CITY/CITY PLUS/LIKE/VIP/ART/FLEX
5533	ASPEN/FAST/LOREN ONE/ALAMO
25	ATRIUM
31	AVALON
34	BALI/HALL
43	BELLE EPOQUE/OXFORD
18522	BOSS
26	CALYPSO
6032	CALYPSO PLUS
17	CARRARA/NUOVA/DUNA/LINK/LK/LEVEL/OMEGA/HAPPENING/VESUVIO/ESTORIL
1	CONVENCIONAL
1657	CONVENCIONAL PNE SEM TAMPA
15307	CONVENCIONAL PNE COM TAMPA
24023	DEBBA
35	DONNA
40	DUOMO PLUS
26544	ELITE
36	EROS
25581	FLOX
28	HAMPTON
16	IBIZA
25582	LIRIO
2695	LUNA
24041	MALVA BRANCA
19	MONTE CARLO/TURIM
27	NUAGE
20	PARIS/EZEDRA
17404	QUADRA/PIANO/POLO/AXIS/UNIC/GAP/LOREN LIKE
42	RAVENA/TARGA/IZY/STUDIO

CODE	MODEL
32	RIVIERA/NEXO/SMART/NEO
29	SABATINI/DONA BEJA
17841	SPOT
15	SQUARE
13	STYLUS/PRIMULA PLUS
24024	SUITE
22	THEMA/HAWAII
18	TIVOLI
47	UP/ALOHA
23	VERSATO/FIT/SAVARY
30	VICTORIA ABSOLUTE
33	VILLAGE
24	VOGUE PLUS/ETNA
15308	VOGUE PLUS/ETNA PNE COM TAMPA
6096	VOGUE PLUS/ETNA PNE SEM TAMPA

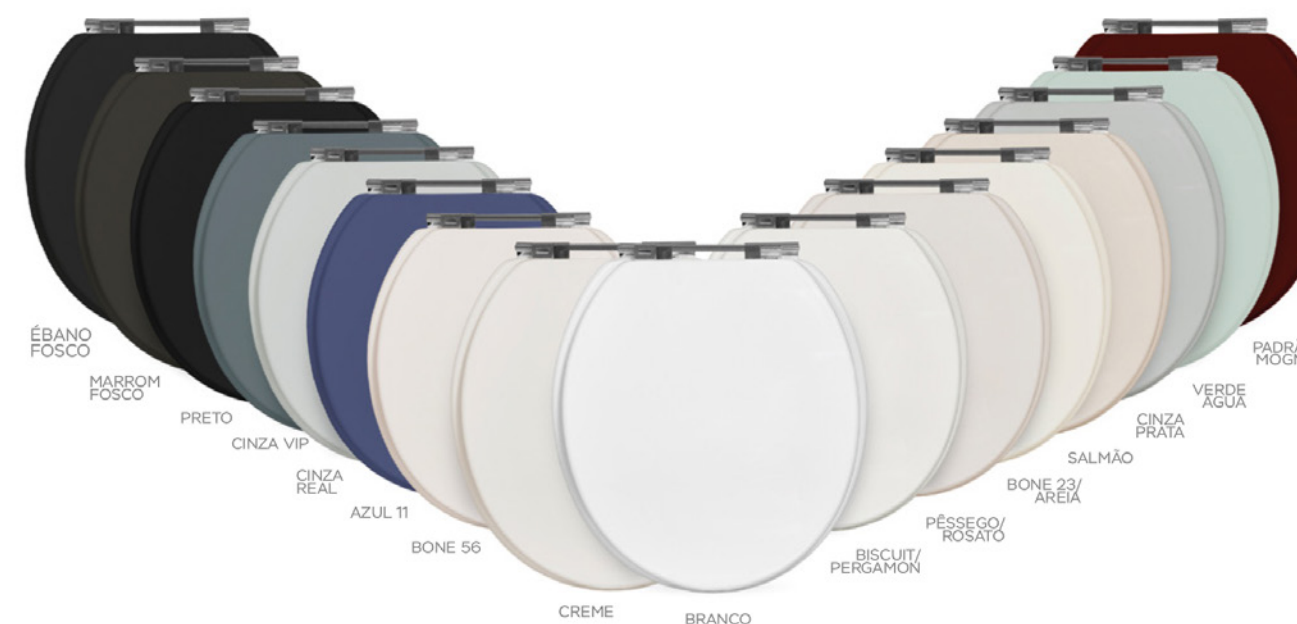



## TOILET SEATS

# SOFT CLOSE



**Sicmol**  
THE BEST TOILET SEAT

CODE	MODEL
24291	CONVENCIONAL
24369	VERSATO
24368	MONTE CARLO
24292	RIVIERA/NEXO/SMART
24294	THEMA
24293	SABATINI/LIFE/VOGUE PLUS
24295	CARRARA/DUNA
24296	QUADRA



UNIT PACK



MASTER PACK

AVAILABLE ONLY IN WHITE COLOR.

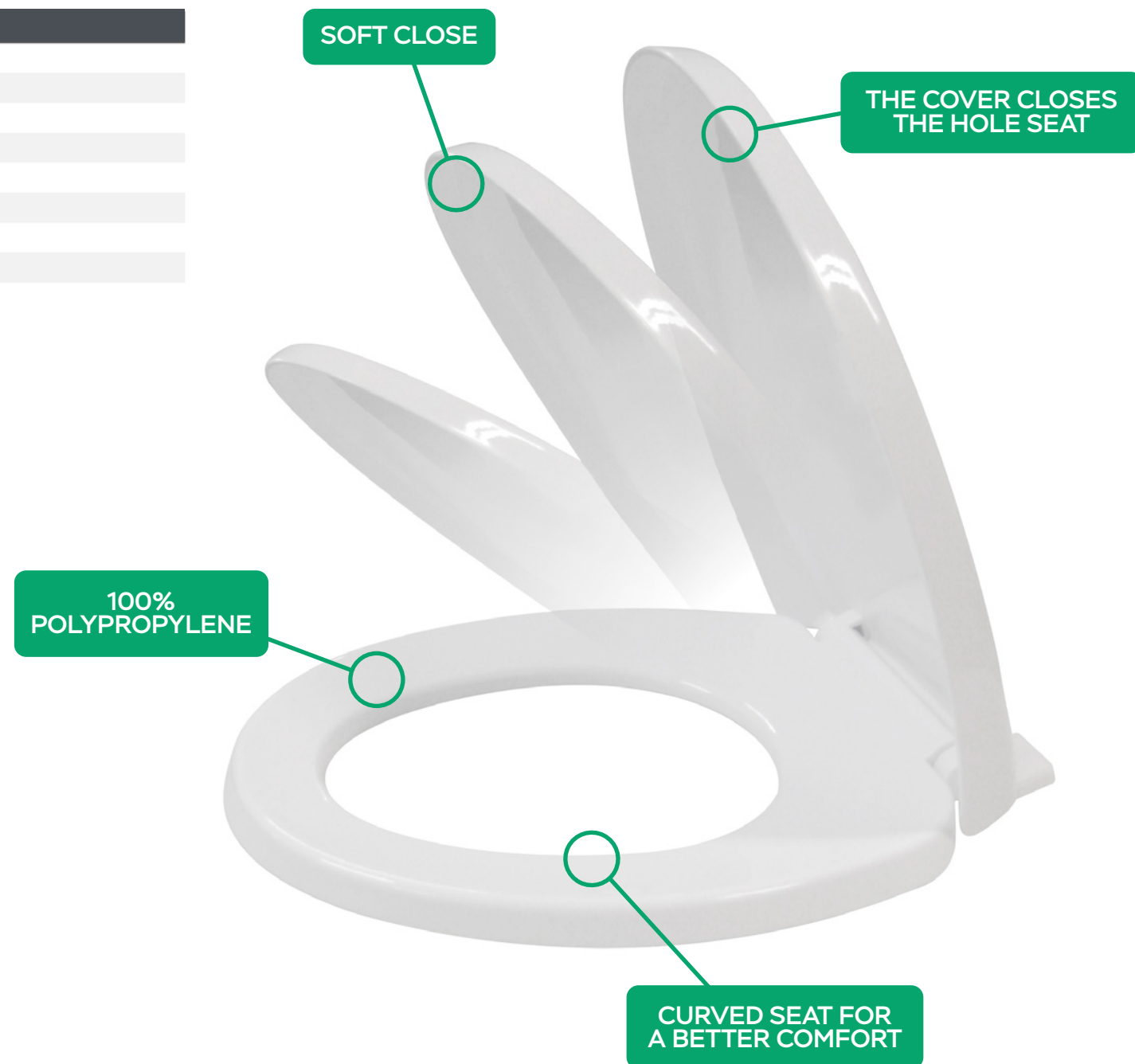

## CHARACTERISTICS

- MODERN DESIGN.
- HIGH DURABILITY.
- EASY CLEANING.
- 100% WATERPROOF.
- HIGH GLOW.
- INSTALLATION KIT.
- EASY INSTALLATION.

## COMPOSITION

- TOILET SEAT / HINGE: 100% POLYPROPYLENE.

## MASTER PACK

- 10 UNITS.

## TOILET SEATS

# CUSHIONED

CODE	MODEL
23565	CONVENCIONAL
23566	THEMA
23567	MULTI - 14 EM 1 COMPATÍVEL COM: SABATINI (ICASA), RIVIERA (CELITE), LIFE (CELITE), VOGUE PLUS (DECA), NEXO (ROCA), SMART (CELITE), PARIS (IDEAL STANDARD), ETNA (ICASA), DEBBA (ROCA), SQUARE (INCEPA), ASPEN (DECA), FAST (DECA), CITY (CELITE), ÍBIZA (INCEPA).



UNIT PACK



MASTER PACK

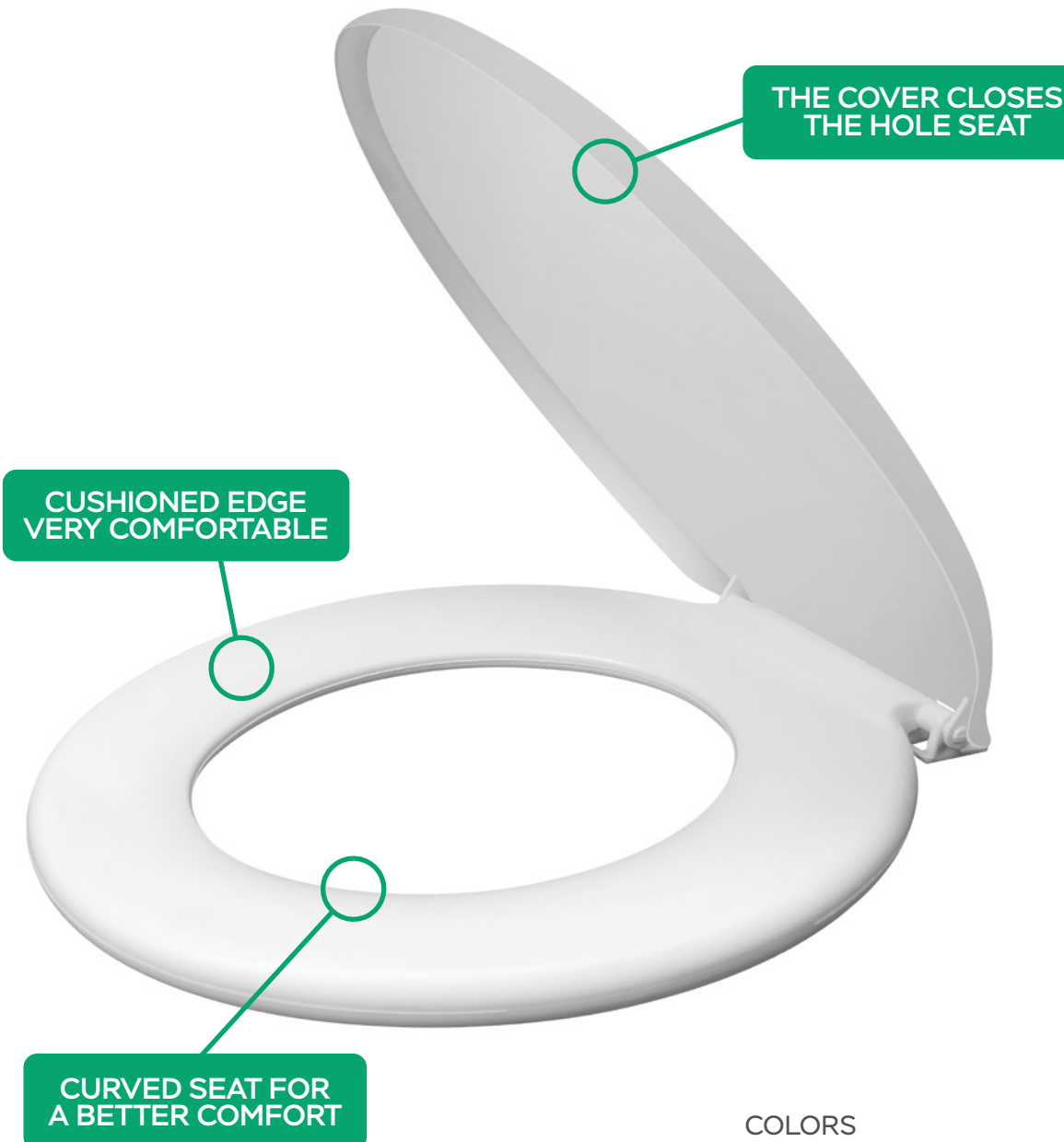

### COLORS



# Sicmol

THE BEST TOILET SEAT

## CHARACTERISTICS

- VERY COMFORTABLE.
- HIGH DURABILITY.
- EASY CLEANING.
- 100% WATERPROOF.
- HIGH GLOW.
- INSTALLATION KIT.
- EASY INSTALLATION.

## COMPOSITION

- TOILET SEAT / HINGE: 100% POLYPROPYLENE.
- EDGE: BLOWN INTO EVA AND INJECTED WITH PU.

## MASTER PACK

- 5 UNITS.

## TOILET SEATS

# POLYPROPYLENE



**Sicmol**  
THE BEST TOILET SEAT

CODE	MODEL
23574	CONVENCIONAL



UNIT PACK



MASTER PACK

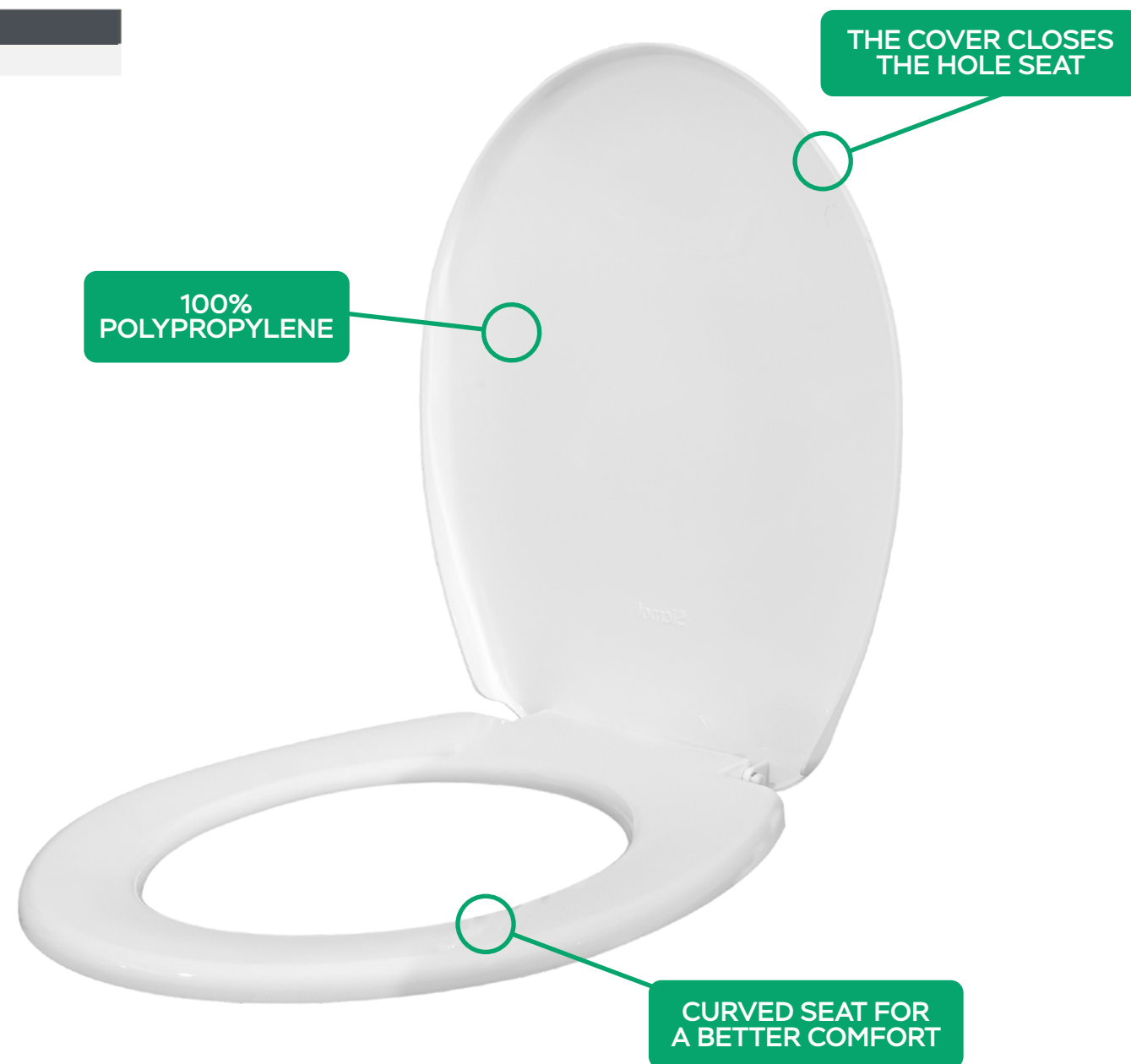

## CHARACTERISTICS

- TOO COMFORTABLE.
- HIGH DURABILITY.
- EASY CLEANING.
- 100% WATERPROOF.
- HIGH GLOW.
- SHOCK ABSORBERS.
- INSTALLATION KIT.
- EASY INSTALLATION.

## COMPOSITION

- TOILET SEAT / HINGE: 100% POLYPROPYLENE.

## MASTER PACK

- 5 UNITS.

AVAILABLE ONLY IN WHITE COLOR.



## TOILET SEATS

# SLIM



**Sicmol**  
THE BEST TOILET SEAT

CODE	MODEL
25849	CONVENCIONAL

THE COVER CLOSES  
THE HOLE SEAT



UNIT PACK



MASTER PACK

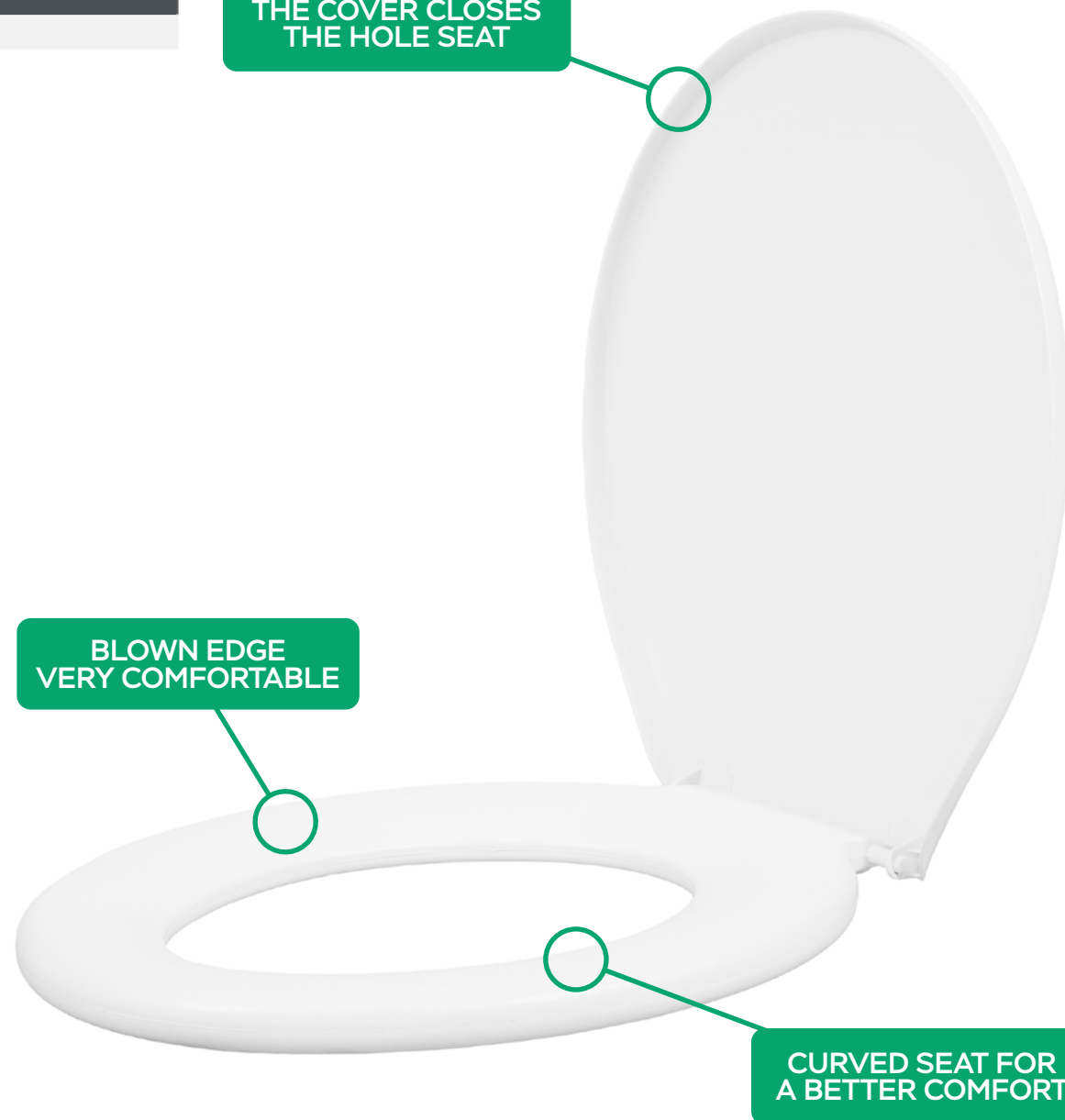

BLOWN EDGE  
VERY COMFORTABLE

CURVED SEAT FOR  
A BETTER COMFORT

## CHARACTERISTICS

- TOO COMFORTABLE.
- HIGH DURABILITY.
- EASY CLEANING.
- 100% WATERPROOF.
- HIGH GLOW.
- INSTALLATION KIT.
- EASY INSTALLATION.

## COMPOSITION

- TOILET SEAT / HINGE: 100% POLYPROPYLENE.

## MASTER PACK

- 5 UNITS.

AVAILABLE ONLY IN WHITE COLOR.

## TOILET SEATS

# BRASILEIRINHO



**Sicmol**  
THE BEST TOILET SEAT

CODE	MODEL
1501	CONVENCIONAL/UNIVERSAL



UNIT PACK



MASTER PACK

AVAILABLE ONLY IN WHITE COLOR.



## CHARACTERISTICS

- TOO COMFORTABLE.
- HIGH DURABILITY.
- EASY CLEANING.
- 100% WATERPROOF.
- HIGH GLOW.
- INSTALLATION KIT.
- EASY INSTALLATION.

## COMPOSITION

- TOILET SEAT / HINGE: 100% POLYPROPYLENE.

## MASTER PACK

- 5 UNITS.





# SAFETY GRAB BARS



PIPE DIAMETER: 31,75MM, BEING 1.1/4".

## ANODIZED

- L TOILET COD. 23753
- U TOILET COD. 23754
- L WASHBASIN COD. 23755
- U WASHBASIN COD. 23756
- FOLDING COD. 23757
- FIXED SIDE COD. 24870
- CORNER SUP. BAR COD. 24904
- SAFETY GRAB BAR L 60 COD. 25254
- SAFETY GRAB BAR L 80 COD. 25255

## WHITE

- L TOILET COD. 24850
- U TOILET COD. 24852
- L WASHBASIN COD. 24882
- U WASHBASIN COD. 24883
- FOLDING COD. 24884
- FIXED SIDE COD. 24885

## COLORS



ANODIZED WHITE



FIXED SIDE  
300X195MM



U WASHBASIN  
680X220X480MM



L WASHBASIN  
620X220X480MM



L TOILET  
730X800X220MM



U TOILET  
900X800X220MM



FOLDING  
700X195X160MM



CORNER  
SUPPORT BAR  
150X150MM



SAFETY GRAB BAR L  
600X600MM  
800X800MM



RAW MATERIAL: COLORED: ALUMINIUM WITH ELECTROTASTIC PAINT.  
ANODIZED: ANODIZED ALUMINIUM AND CHROMED ABS FINISHING. DOES NOT RUST.

# SAFETY GRAB BARS

PIPE DIAMETER: 31,75MM, BEING 1.1/4".

## CURVED COLORS

45CM COD. 18141  
60CM COD. 18142

## STRAIGHT COLORS

30CM COD. 18131  
45CM COD. 18132  
60CM COD. 18138  
80CM COD. 18139  
90CM COD. 18140

## CURVED ANODIZED

45CM COD. 4775  
60CM COD. 4776

## STRAIGHT ANODIZED

30CM COD. 4770  
45CM COD. 4772  
60CM COD. 4773  
80CM COD. 14566  
90CM COD. 4774

### COLORS



ANODIZED WHITE BLACK



RAW MATERIAL: COLORED: ALUMINIUM WITH ELECTROTASTIC PAINT.  
ANODIZED: ANODIZED ALUMINIUM AND CHROMED ABS FINISHING. DOES NOT RUST.

# SUPPORT BAR

PIPE DIAMETER: 25MM, BEING 1".

## CURVED ANODIZED

45CM COD. 1505  
60CM COD. 1506

## STRAIGHT ANODIZED

30CM COD. 1474  
45CM COD. 1502  
60CM COD. 1503  
80CM COD. 14565  
90CM COD. 1504

## STRAIGHT WHITE

30CM COD. 25866  
45CM COD. 25867  
60CM COD. 25868  
80CM COD. 25869  
90CM COD. 25870

### COLORS



ANODIZED WHITE





# STRAIGHT BATH CHAIR

STRAIGHT BATH CHAIR WITH ARM  
COD. 26250

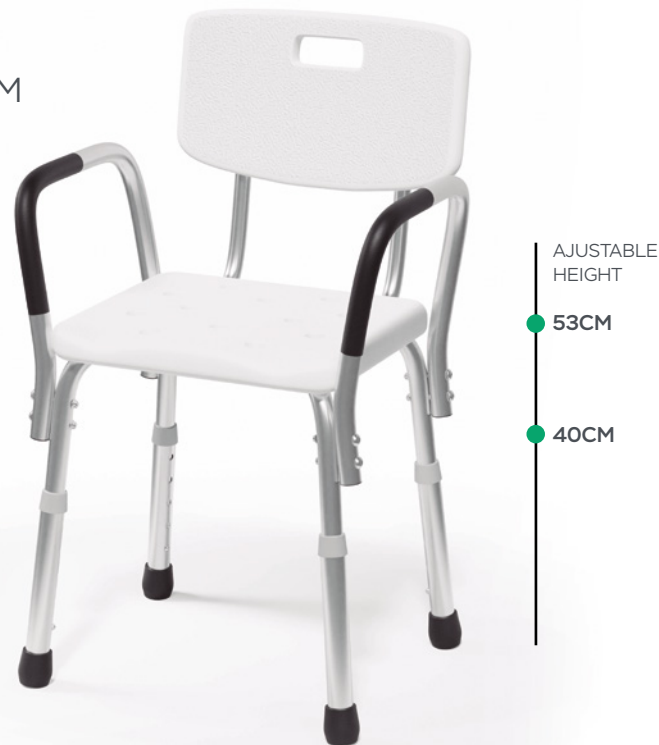

STRAIGHT BATH CHAIR WITHOUT ARM  
COD. 26255



STRAIGHT BATH CHAIR  
COD. 26307



DISASSEMBLED PACKAGED PRODUCT.

RAW MATERIAL: HIGH DENSITY POLYETHYLENE AND ANODIZED ALUMINUM. DOES NOT OXIDIZE.





# CURVED BATH CHAIR

CURVED BATH CHAIR WITH ARM  
COD. 26256



CURVED BATH CHAIR WITHOUT ARM  
COD. 26258

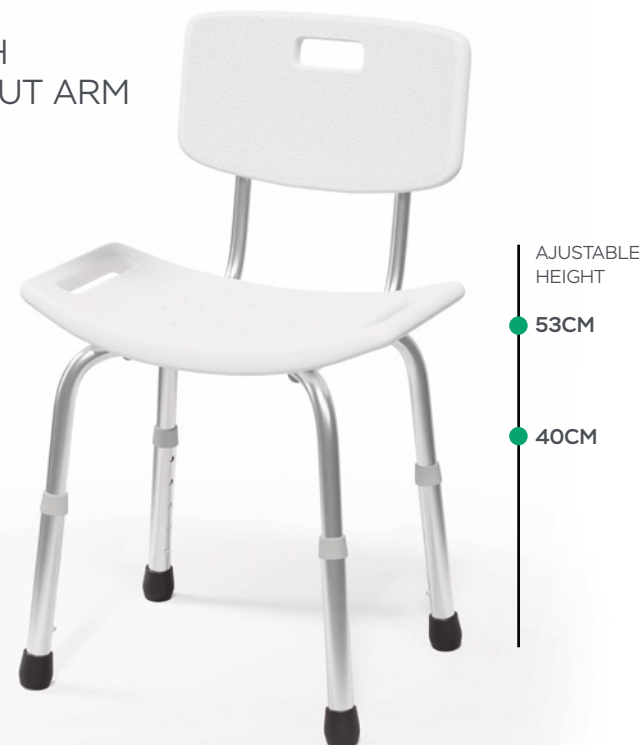

CURVED BATH CHAIR  
COD. 26308



DISASSEMBLED PACKAGED PRODUCT.

RAW MATERIAL: HIGH DENSITY POLYETHYLENE AND ANODIZED ALUMINUM. DOES NOT OXIDIZE.



# BATH CHAIR WITH FRONT OPENING

BATH CHAIR WITH  
FRONT OPENING  
AND ARM  
COD. 26259



BATH CHAIR WITH  
FRONT OPENING  
AND WITHOUT ARM  
COD. 26260



BATH CHAIR WITH FRONT OPENING  
COD. 26309



DISASSEMBLED PACKAGED PRODUCT.

RAW MATERIAL: HIGH DENSITY POLYETHYLENE AND ANODIZED ALUMINUM. DOES NOT OXIDIZE.

# CHAIRS AND STOOLS



TOILET SAFETY FRAME  
560X720X400MM  
COD. 24524

COMPATIBLE WITH MULTIPLE  
TOILETS.



SHOWER CHAIR  
560X720X380MM  
COD. 24614

SHOWER STOOL  
450X200X420MM  
COD. 24549

TOILET STOOL: WITH VERTICAL  
SECURITY LOCK.

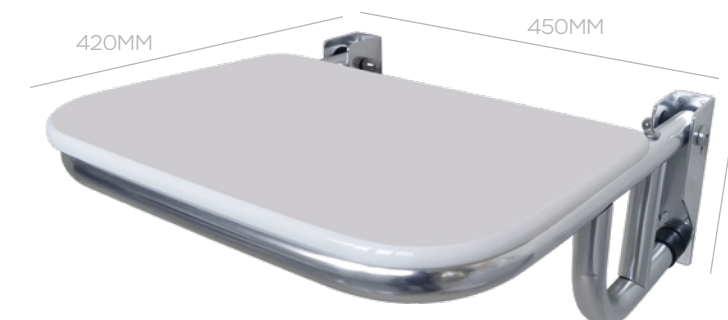

RAW MATERIAL: ALUMINIUM/ POLYESTER 'S RESIN . DOES NOT RUST.

## TOILET STOOL

### WITH LID

CONVENTIONAL  
MDF COD. 15307  
POLYESTER COD. 15314

VOGUE PLUS  
MDF COD. 15308  
POLYESTER COD. 15315

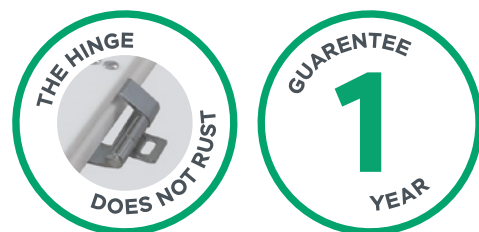

THE THICKNESS OF THE TOILET SEAT IS 25 MM.  
ONLY IN WHITE COLOR.

RAW MATERIAL: POLYESTER RESIN ALUMINIUM.  
HINGE DOES NOT RUST.

## TOILET SEATS

### WITHOUT LID

CONVENTIONAL  
MDF COD. 1657  
POLYESTER COD. 688

VOGUE PLUS  
MDF COD. 6096  
POLYESTER COD. 6374







# GLASS SHELF

CURVED GLASS SHOWER SHELF  
 150X150MM COD. 24112  
 200X200MM COD. 24202  
 250X250MM COD. 24203

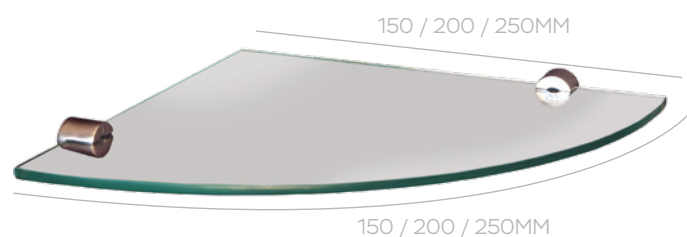

STRAIGHT GLASS SHELF  
 300X100MM COD. 24196  
 300X150MM COD. 24200  
 300X200MM COD. 24521

400X100MM COD. 24197  
 400X150MM COD. 24201  
 400X200MM COD. 24522

500X100MM COD. 24198  
 500X150MM COD. 24519  
 500X200MM COD. 24523

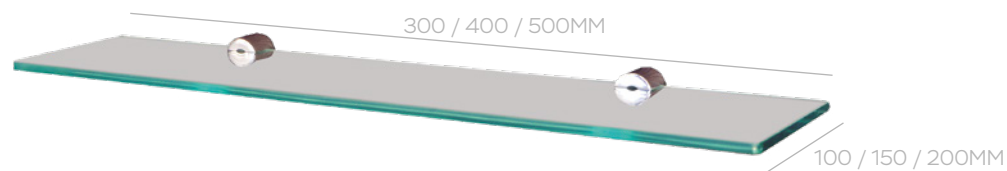

THE SHELF SUPPORT IS 18 MM.

RAW MATERIAL: METAL + TEMPERED GLASS.

# SHOWER SHELF

STRAIGHT BATH ORGANIZER  
 500X104X50MM  
 COD. 24111

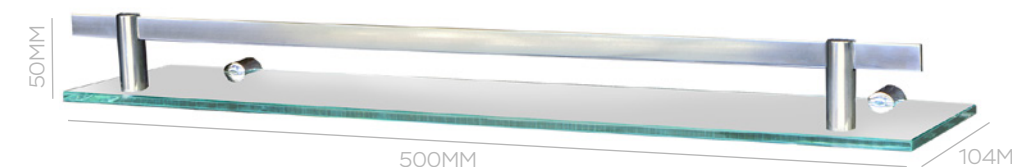

CURVED BATH ORGANIZER  
 244X244X50MM  
 COD. 24113

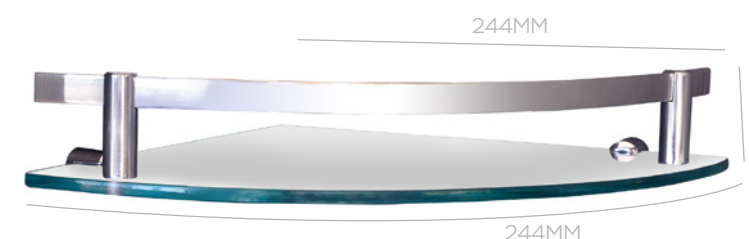

RAW MATERIAL: POLISHED ALUMINIUM + TEMPERED GLASS 6 MM.  
 DOES NOT RUST.



# HOOKS

HOOKS 3 HANGERS  
185X45MM  
COD. 24494



HOOKS 5 HANGERS  
300X45MM  
COD. 24495

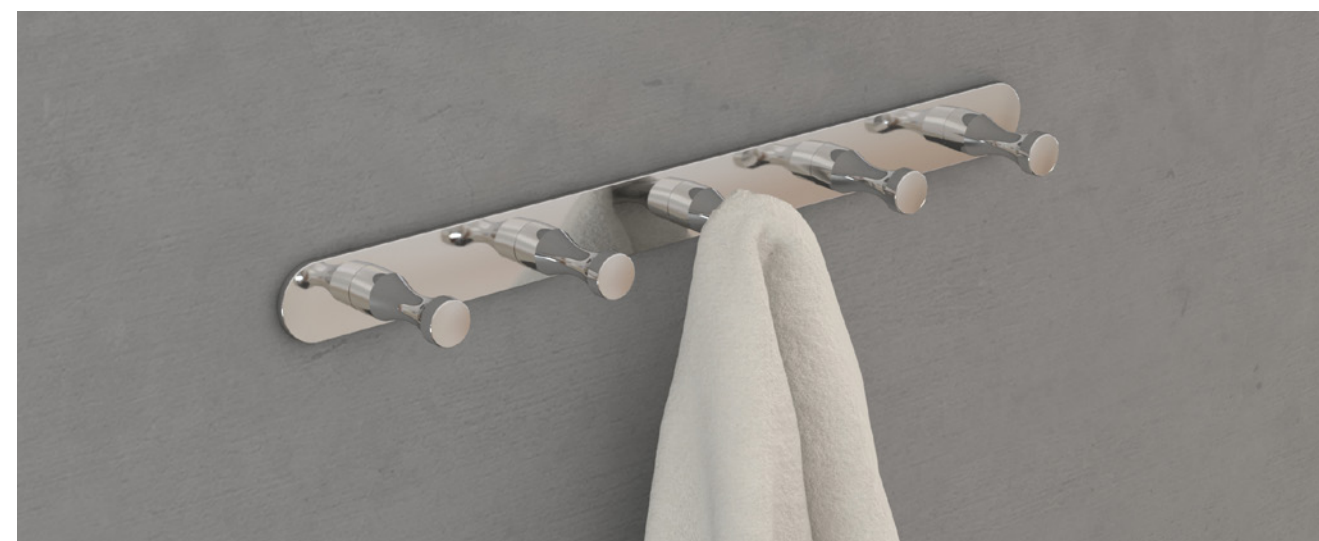
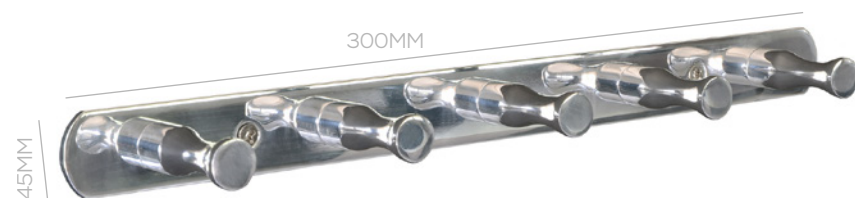

RAW MATERIAL: ALUMINIUM. DOES NOT RUST.

HOOKS 3 HANGERS  
175X55X30MM  
COD. 25686



HOOKS 4 HANGERS  
237X55X30MM  
COD. 25687



HOOKS 6 HANGERS  
355X55X30MM  
COD. 25688



RAW MATERIAL: CHROMED ALUMINIUM. DOES NOT RUST.



# TOWEL RACK WITH SUPPORT

TOWEL RACK MODEL 1  
600X230X150MM  
COD. 1380



TOWEL RACK MODEL 2  
395X230X150MM  
COD. 1381

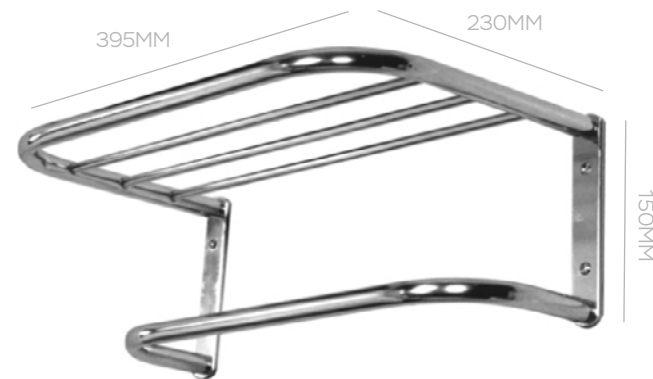

RAW MATERIAL: ALUMINIUM. DOES NOT RUST.





# TOWEL RACK FOR BATHROOM BOX

4 HOOKS 1 BAR  
395X265X235MM  
COD. 25323

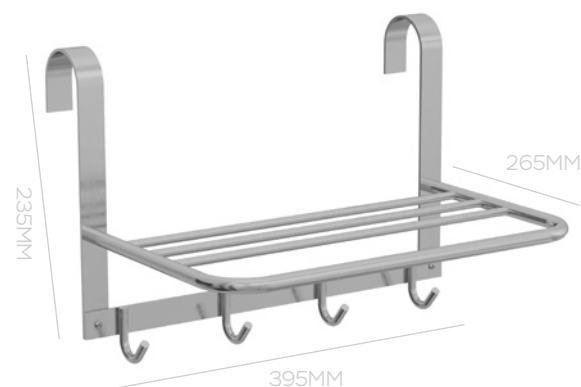

TOWEL RACK SUPPORT  
4 HOOKS  
395X225X180MM  
COD. 25320

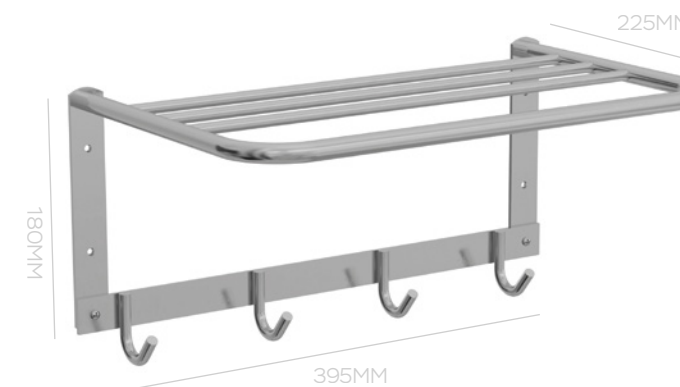

TOWEL RACK 2 BARS  
395X265X235MM  
COD. 25322

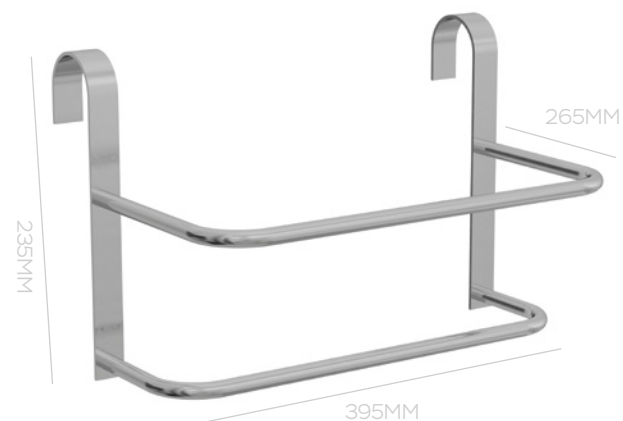

TOWEL RACK SUPPORT  
5 HOOKS  
600X225X180MM  
COD. 25321

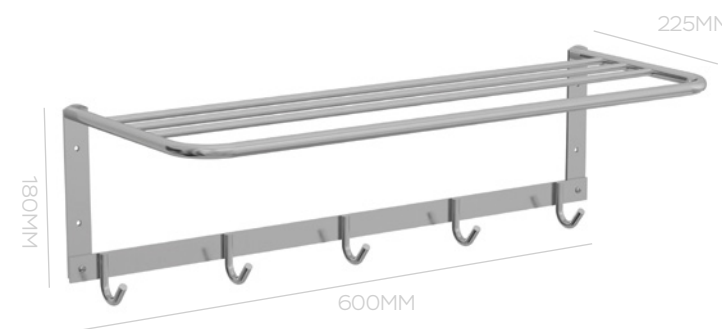

RAW MATERIAL: CHROMED ALUMINIUM. DOES NOT RUST.



# LUXO SICWOOD LINE



LUXO WOOD/ALUMINIUM  
HOOK  
COD. 25938



LUXO WOOD/ALUMINIUM  
SOAP DISH  
COD. 25941



LUXO WOOD/ALUMINIUM  
PAPER HOLDER  
COD. 25942



LUXO WOOD/ALUMINIUM  
TOWEL RING  
COD. 25943



LUXO WOOD/ALUMINIUM  
TOWEL RACK  
COD. 25944

RAW MATERIAL: 100% REFORESTED WOOD/ALUMINIUM  
WITH ELETROTASTIC PAINT.

# MODERNO SICWOOD LINE

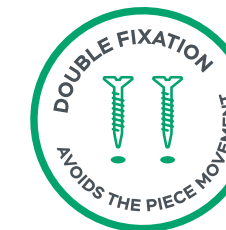

MODERNO WOOD/  
ALUMINIUM HOOK  
COD. 25911



MODERNO WOOD/  
ALUMINIUM SOAP DISH  
COD. 25912



MODERNO WOOD/  
ALUMINIUM PAPER HOLDER  
COD. 25913



MODERNO WOOD/  
ALUMINIUM TOWEL RING  
COD. 25914



MODERNO WOOD/  
ALUMINIUM TOWEL RACK  
COD. 25915

RAW MATERIAL: 100% REFORESTED WOOD.

# RUSTIC SICWOOD LINE

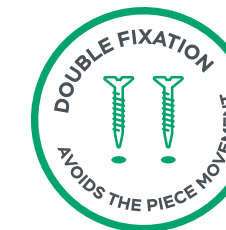

RUSTIC WOOD/ALUMINIUM  
HOOK  
COD. 25925



RUSTIC WOOD/ALUMINIUM  
SOAP DISH  
COD. 25926



RUSTIC WOOD/ALUMINIUM  
PAPER HOLDER  
COD. 25927



RUSTIC WOOD/ALUMINIUM  
TOWEL RING  
COD. 25928



RUSTIC WOOD/ALUMINIUM  
TOWEL RACK  
COD. 25929

RAW MATERIAL: 100% REFORESTED WOOD.



# INOVARE LINE

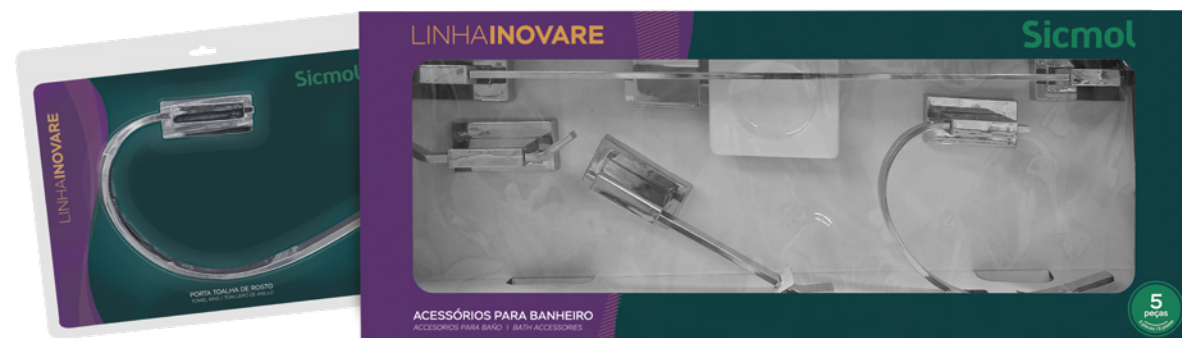

KIT INOVARE 5 PIECES  
COD. 22462



HOOK COD. 22478



SOAP DISH COD. 22480



PAPER HOLDER COD. 22479



TOWEL RING  
COD. 22481



TOWEL RACK  
COD. 22482

RAW MATERIAL: SOLID ALUMINIUM AND ABS FINISHED.  
DOES NOT RUST.

# MAISS LINE



KIT MAISS 5 PIECES  
COD. 24249



HOOK COD. 24263



SOAP DISH COD. 24265



PAPER HOLDER COD. 24264



TOWEL RING  
COD. 24266



TOWEL RACK  
COD. 24267



SE VENDE POR  
SEPARADO  
STRAIGHT GLASS SHELF  
COD. 24382

RAW MATERIAL: SOLID ALUMINIUM AND ABS FINISHED.  
DOES NOT RUST.



# RENOVE LINE



KIT RENOVE 5 PIECES  
COD. 22461

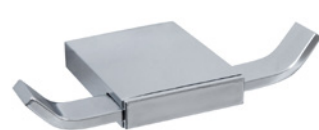

HOOK



SOAP DISH



PAPER HOLDER



TOWEL RING



TOWEL RACK

RAW MATERIAL: SOLID ALUMINIUM AND ABS FINISHED.  
DOES NOT RUST.

# KROMUS LINE

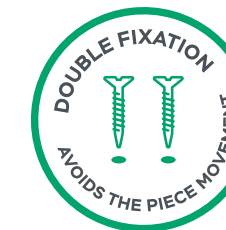

KIT KROMUS 5 PIECES  
COD. 22460



HOOK COD. 22468



SOAP DISH COD. 22470



PAPER HOLDER COD. 22469



TOWEL RING  
COD. 22471



TOWEL RACK  
COD. 22472

# SLIM KIT

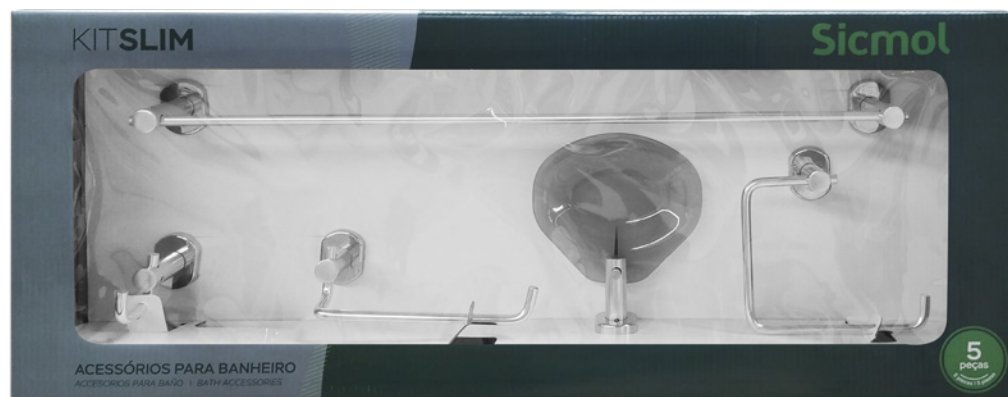

KIT SLIM 5 PIECES  
COD. 24476



HOOK



SOAP DISH



PAPER HOLDER



TOWEL RING



TOWEL RACK

RAW MATERIAL: SOLID ALUMINIUM AND ABS FINISHED.  
DOES NOT RUST.

# STYLO LINE



KIT STYLO 5 PIECES  
COD. 1533

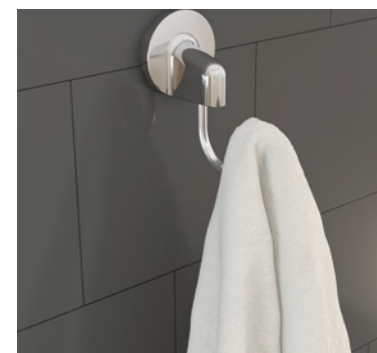

HOOK COD. 1544

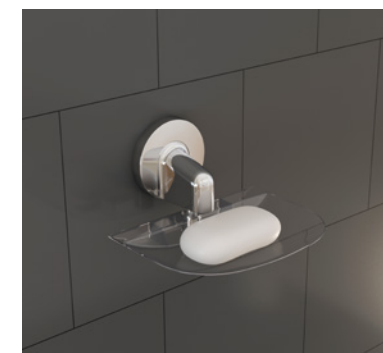

SOAP DISH COD. 1550



PAPER HOLDER COD. 1553



TOWEL RING  
COD. 1527

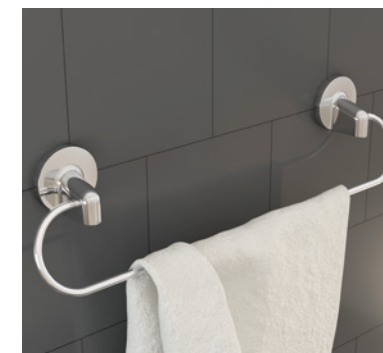

TOWEL RACK  
COD. 1477



STRAIGHT SHELF  
COD. 1539

THIS ITEM  
IS SOLD  
SEPARATELY.

RAW MATERIAL: CHROMED ABS/ANODIZED ALUMINIUM AND CRYSTAL  
POLYESTIRENE. DOES NOT RUST.





# PLUS LINE



KIT PLUS 3 PEÇAS  
COD. 1531



HOOKS  
2 PIECES  
COD. 25318



KIT PLUS  
6 PIECES COD. 19392  
7 PIECES COD. 1478



HOOK  
COD. 1490



SOAP DISH  
COD. 1499



PAPER HOLDER  
COD. 1500



TOWEL RING  
COD. 1525

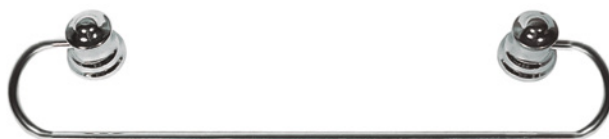

TOWEL RACK  
COD. 1476



STRAIGHT SHELF  
COD. 1488

THIS ITEM IS A PART  
OF THE 7 PIECES KIT.

RAW MATERIAL: CHROMED ABS/ANODIZED ALUMINIUM AND CRYSTAL POLYESTIRENE. DOES NOT RUST.

# SICDECORE KIT



KIT SICDECORE 5 PIECES  
COD. 4813



HOOK



SOAP DISH



PAPER HOLDER



TOWEL RING



TOWEL RACK





## GREAT ADVANTAGES OF MDP

1. Lighter.
2. Supports more weight.
3. Ideal for humid environments as its sheets in layer make it harder for the material to expand.
4. Ideal for straight furniture.

# ARUBA LINE

## 1 DOOR AND 2 NICHES



MDP LACQUERED  
BATHROOM VANITY WITH  
WASHBASIN ARUBA  
515X315X485 MM  
COD. 26332



GREY



BROWN



BROWN/WHITE



CARAMEL



CARAMEL/WHITE

RAW MATERIAL: LACQUERED MDP WITH POLYURETHANE Y ULTRAVIOLET.  
SINK: POLYESTER RESIN, GEL COAT AND MINERAL FILLER.  
HANDLE: CHROME ENGINEERED PLASTIC.

-VANITY AND VANITY/MIRROR ARE SOLD SEPARATLY.

# ARUBA LINE

## 2 DOORS AND 2 NICHE



MDP LACQUERED  
BATHROOM VANITY WITH  
WASHBASIN ARUBA  
715X315X485 MM  
COD. 26333



GREY



BROWN



BROWN/WHITE



CARAMEL



CARAMEL/WHITE

RAW MATERIAL: LACQUERED MDP WITH POLYURETHANE Y ULTRAVIOLET.  
SINK: POLYESTER RESIN, GEL COAT AND MINERAL FILLER.  
HANDLE: CHROME ENGINEERED PLASTIC.

-VANITY AND VANITY/MIRROR ARE SOLD SEPARATLY.



# BOSTON LINE

## 1 DOOR AND 2 DRAWERS



MDP LACQUERED  
BATHROOM VANITY WITH  
WASHBASIN BOSTON  
515X315X485 MM  
COD. 26330



WHITE



GREY



BROWN



BROWN/WHITE



CAMEL

RAW MATERIAL: LACQUERED MDP WITH POLYURETHANE Y ULTRAVIOLET.  
SINK: POLYESTER RESIN, GEL COAT AND MINERAL FILLER  
HANDLE: CHROME ENGINEERED PLASTIC.

-VANITY AND VANITY/MIRROR ARE SOLD SEPARATLY.



# BOSTON LINE

## 2 DOORS AND 2 DRAWERS



MDP LACQUERED  
BATHROOM VANITY WITH  
WASHBASIN BOSTON  
715X315X485 MM  
COD. 26331



WHITE



BROWN



BROWN/WHITE



CAMEL



CAMEL/WHITE

RAW MATERIAL: LACQUERED MDP WITH POLYURETHANE Y ULTRAVIOLET.  
SINK: POLYESTER RESIN, GEL COAT AND MINERAL FILLER .  
HANDLE: CHROME ENGINEERED PLASTIC.

-VANITY AND VANITY/MIRROR ARE SOLD SEPARATLY.

# BELIZE LINE



MDP LACQUERED  
BATHROOM VANITY WITH  
WASHBASIN BELIZE  
COD. 26338  
COD. 26339



RAW MATERIAL: LACQUERED MDP WITH POLYURETHANE Y ULTRAVIOLET.  
SINK: POLYESTER RESIN, GEL COAT AND MINERAL FILLER.  
HANDLE: CHROME ENGINEERED PLASTIC.

-VANITY AND VANITY/MIRROR ARE SOLD SEPARATLY.



# NASSAU LINE



MDP LACQUERED  
BATHROOM VANITY WITH  
WASHBASIN NASSAU  
WITH FEET Y 2 DOORS  
520X400X810 MM  
COD. 26344



RAW MATERIAL: LACQUERED MDP WITH POLYURETHANE Y ULTRAVIOLET.

-SUPPORT SINK DOES NOT COME WITH THE PRODUCT.  
-VANITY AND VANITY/MIRROR ARE SOLD SEPARATLY.

# MALDIVAS LINE

## 1 DOOR AND 2 NICHES



MDP LACQUERED  
BATHROOM VANITY WITH  
WASHBASIN MALDIVAS  
GLASS CAP

600X400X480 MM  
COD. 26342

800X400X480 MM  
COD. 26343



WHITE



GREY



BROWN



BROWN/WHITE



CARMEL

RAW MATERIAL: LACQUERED MDP WITH POLYURETHANE Y ULTRAVIOLET  
+ TEMPERED GLASS. HANDLE: ANODIZED ALUMINUM.

-SUPPORT SINK DOES NOT COME WITH THE PRODUCT.  
-VANITY AND VANITY/MIRROR ARE SOLD SEPARATLY.



# MALDIVAS LINE

## 1 DOOR AND 2 DRAWERS



MDP LACQUERED  
BATHROOM VANITY WITH  
WASHBASIN MALDIVAS  
GLASS CAP

600X400X480 MM  
COD. 26340

800X400X480 MM  
COD. 26341



WHITE



GREY



BROWN



BROWN/WHITE



CAMEL

RAW MATERIAL: LACQUERED MDP WITH POLYURETHANE Y ULTRAVIOLET  
+ TEMPERED GLASS. HANDLE: ANODIZED ALUMINUM.

-SUPPORT SINK DOES NOT COME WITH THE PRODUCT.  
-VANITY AND VANITY/MIRROR ARE SOLD SEPARATLY.

# PUNTA LINE



MDP LACQUERED  
BATHROOM VANITY WITH  
WASHBASIN PUNTA  
1 TILTIN DOOR 1 NICHE  
COD. 26336  
COD. 26337



GREY



BROWN



BROWN/WHITE



CARAMEL



CARAMEL/WHITE

RAW MATERIAL: LACQUERED MDP WITH POLYURETHANE Y ULTRAVIOLET.  
SINK: POLYESTER RESIN, GEL COAT AND MINERAL FILLER  
HANDLE: CHROME ENGINEERED PLASTIC.

-VANITY AND VANITY/MIRROR ARE SOLD SEPARATLY.



# TAITI LINE



MDP LACQUERED  
BATHROOM VANITY WITH  
WASHBASIN TAITI 2 DOORS  
COD. 26334  
COD. 26335

BROWN



WHITE



GREY



BRONW/WHITE



CARAMEL



CARAMEL/WHITE

RAW MATERIAL: LACQUERED MDP WITH POLYURETHANE Y ULTRAVIOLET.  
SINK: POLYESTER RESIN, GEL COAT AND MINERAL FILLER  
HANDLE: CHROME ENGINEERED PLASTIC.

-VANITY AND VANITY/MIRROR ARE SOLD SEPARATLY.



# KIT XANGAI



KIT MDP LACQUERED  
BATHROOM VANITY  
WITH WASHBASIN AND  
VANITY/MIRROR XANGAI  
515X315X325 MM  
COD. 26345

CARAMEL

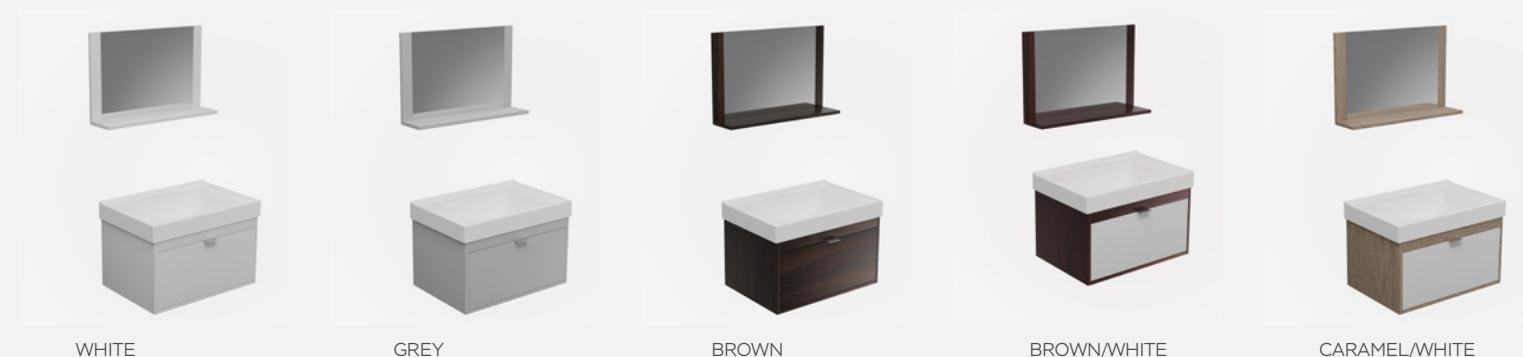

WHITE

GREY

BROWN

BROWN/WHITE

CARAMEL/WHITE

RAW MATERIAL: LACQUERED MDP WITH POLYURETHANE Y ULTRAVIOLET + MIRROR. SINK: POLYESTER RESIN, GEL COAT AND MINERAL FILLER. HANDLE: ANODIZED ALUMINUM. MANIJA: ALUMINIO ANODIZADO.





# VANITY MIRROR DAKAR

## 1 DOOR

MDP LACQUERED  
BATHROOM VANITY/MIRROR  
494X122X472 MM  
COD. 26328

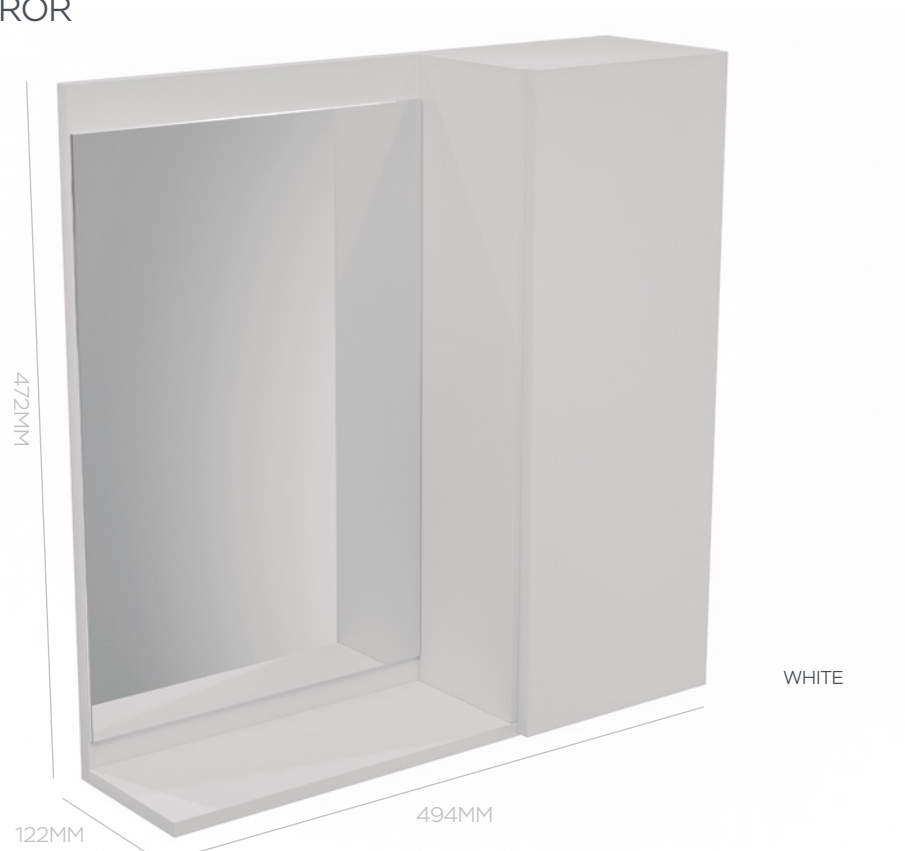

## 2 DOORS

MDP LACQUERED  
BATHROOM VANITY/MIRROR  
674X122X472 MM  
COD. 26329



RAW MATERIAL: LACQUERED MDP WITH POLYURETHANE Y ULTRAVIOLET + MIRROR.

# VANITY MIRROR ANGRA

494X122X472 MM

MDP LACQUERED  
BATHROOM VANITY MIRROR  
COD. 26326

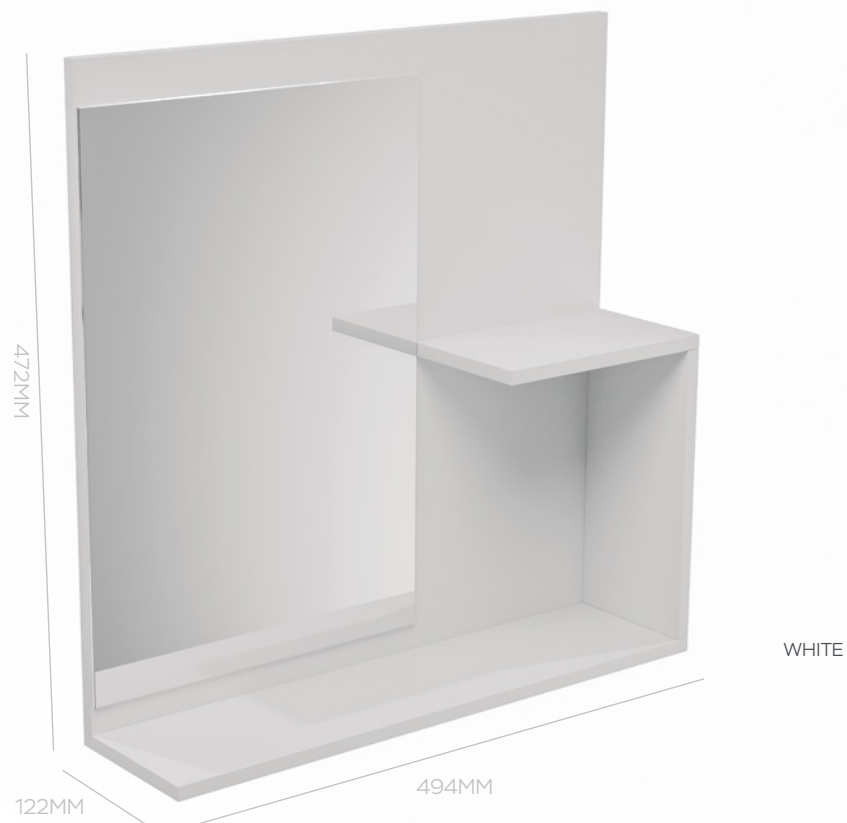

WHITE



GREY



BRONW



CARMEL

674X122X472 MM

MDP LACQUERED  
BATHROOM VANITY MIRROR  
COD. 26327



BROWN



WHITE

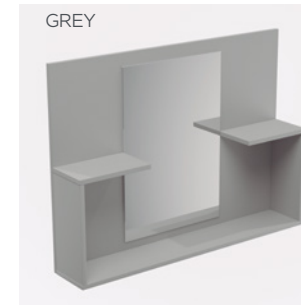

GREY



CARMEL



RAW MATERIAL: LACQUERED MDP WITH POLYURETHANE Y ULTRAVIOLET + MIRROR.



# VANITY MIRROR TULUM

## 2 NICHES

MDP LACQUERED  
BATHROOM VANITY  
MIRROR TULUM  
494X122X472 MM  
COD:26324



CAMEL

WHITE



GREY



BROWN



## 4 NICHES

MDP LACQUERED  
BATHROOM VANITY  
MIRROR TULUM  
674X122X472  
COD:26325



BROWN

WHITE



GREY



CAMEL



RAW MATERIAL: LACQUERED MDP WITH POLYURETHANE Y ULTRAVIOLET + MIRROR.





# NEW LINE

VANITY WITH WASHBASIN  
600X380X600MM  
COD. 13496



FINISHING



WHITE

RAW MATERIAL: LACQUERED MDF WITH POLYURETHANE Y ULTRAVIOLET.  
SINK: POLYESTER RESIN, GEL COAT AND MINERAL FILLER.



THE VANITY WITH MIRROR IS NOT INCLUDED IN THIS LINE.





# ROMA LINE

KIT MDP LACQUERED  
WITH 1 DOOR/WASHBASIN  
AND MIRROR  
420X330X370MM  
COD. 26047

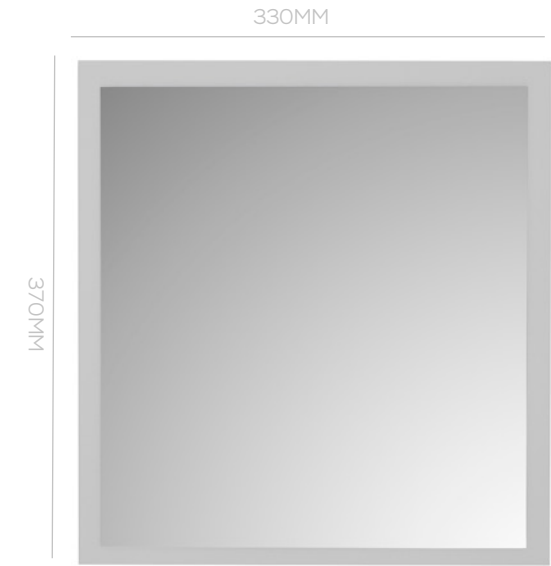
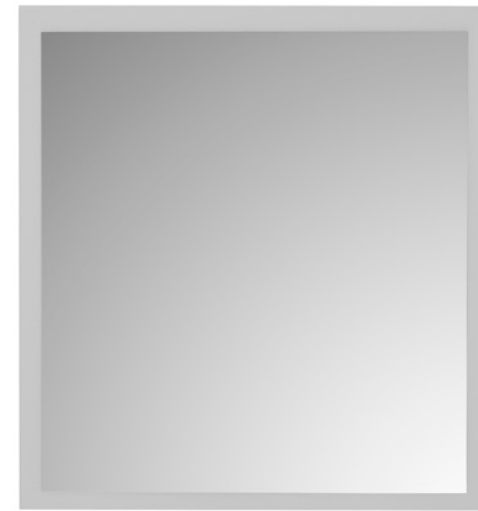
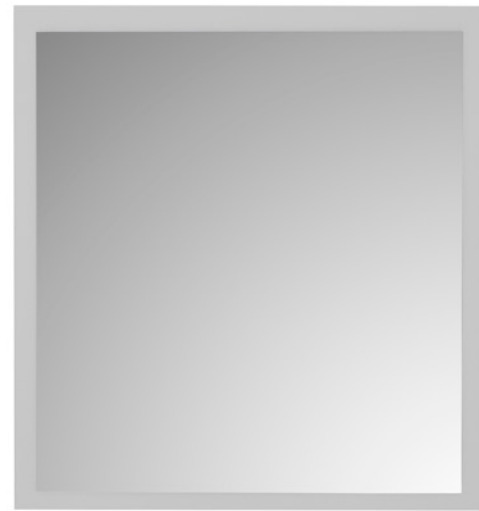

FINISHING



WHITE WHITE/BLACK WHITE/IPE

RAW MATERIAL: MDP WOOD COVERED AND MIRROR.  
WASHBASIN: POLYESTER RESIN GEL COAT AND MINERAL FILLER.

# DETALLY LINE

VANITY WITH WASHBASIN  
1 DOOR / 3 DRAWERS  
600X370X710MM  
COD. 24736

VANITY 1 DOOR  
560X125X580MM  
COD. 24737

VANITY WITH WASHBASIN  
2 DOORS / 3 DRAWERS  
800X370X710MM  
COD. 24738

VANITY 2 DOORS  
760X125X580MM  
COD. 24739

### FINISHING

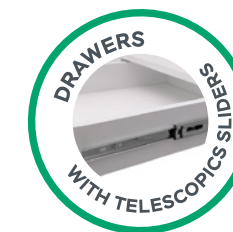
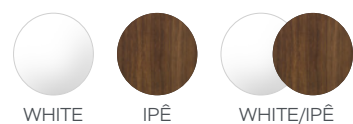

RAW MATERIAL: LACQUERED MDF WITH POLYURETHANE Y ULTRAVIOLET.  
SINK: POLYESTER RESIN, GEL COAT AND MINERAL FILLER.

SUSPENDED VERSION AVAILABLE.

# IDEALLY LINE

VANITY WITH WASHBASIN  
1 DOOR / 2 DRAWERS  
600X370X490MM  
COD. 24740

VANITY 1 DOOR  
560X125X580MM  
COD. 24741

VANITY WITH WASHBASIN  
2 DOORS / 2 DRAWERS  
800X370X490MM  
COD. 24742

VANITY 2 DOORS  
760X125X580MM  
COD. 24743

FINISHING



RAW MATERIAL: LACQUERED MDF WITH POLYURETHANE Y ULTRAVIOLET.  
SINK: POLYESTER RESIN, GEL COAT AND MINERAL FILLER.



# VETRO KIT

VETRO KIT  
1 DOOR / 2 DRAWERS  
COD. 24042

VANITY WITH WASHBASIN  
1 DOOR / 2 DRAWERS  
595X385X590MM

VANITY/MIRROR  
600X180X590MM

VETRO KIT  
2 DOORS  
COD. 24043

VANITY WITH WASHBASIN  
2 DOORS  
595X385X590MM

VANITY/MIRROR  
600X180X590MM

FINISHING

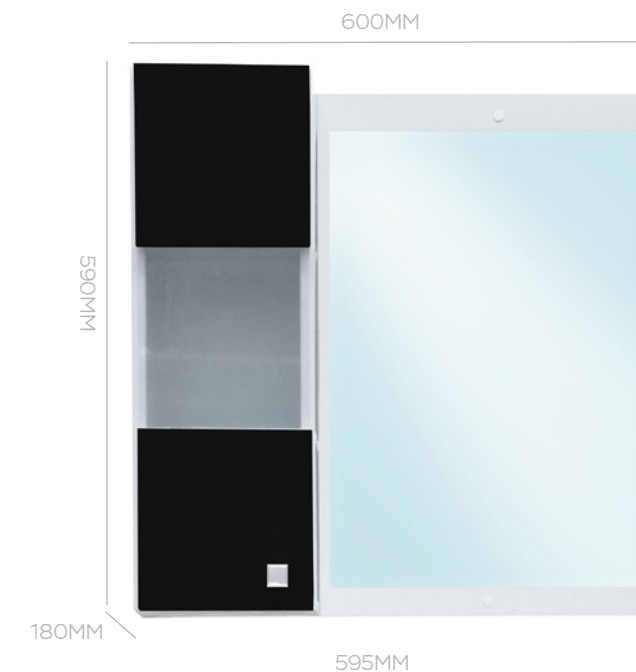
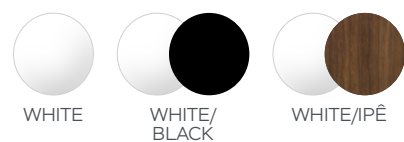

RAW MATERIAL: LACQUERED MDF/MDP WITH POLYURETHANE Y ULTRAVIOLET.  
SINK: POLYESTER RESIN, GEL COAT AND MINERAL FILLER.

# MODERN LINE

VANITY WITH WASHBASIN  
1 DOOR / 2 DRAWERS  
600X375X595MM  
COD. 24734

VANITY 1 DOOR  
560X125X580MM  
COD. 24735

FINISHING



RAW MATERIAL: LACQUERED MDF WITH POLYURETHANE Y ULTRAVIOLET.  
SINK: POLYESTER RESIN, GEL COAT AND MINERAL FILLER.



# SIENA KIT

SIENA KIT  
1 DOOR / 3 DRAWERS  
COD. 23481

VANITY WITH WASHBASIN  
510X315X480MM

MIRROR  
510X130X370MM



SIENA KIT  
2 DOORS / 3 DRAWERS  
COD. 23483

VANITY WITH WASHBASIN  
630X315X480MM

MIRROR  
510X130X370MM



### FINISHING



RAW MATERIAL: LACQUERED MDF/MDP WITH POLYURETHANE Y ULTRAVIOLET.  
SINK: POLYESTER RESIN, GEL COAT AND MINERAL FILLER.





# FIT KIT

VANITY WITH WASHBASIN  
AND MIRROR  
COD. 23278

VANITY WITH WASHBASIN  
420X325XX490MM

MIRROR  
330X370MM



### FINISHING



RAW MATERIAL: LACQUERED MDF/MDP WITH POLYURETHANE Y ULTRAVIOLET.  
SINK: POLYESTER RESIN, GEL COAT AND MINERAL FILLER.



# TANGO KIT

VANITY WITH WASHBASIN  
AND MIRROR  
COD. 26122

VANITY WITH WASHBASIN  
510X870X315MM

MIRROR  
590X330MM

FINISHING



WHITE



RAW MATERIAL: LACQUERED MDF/MDP WITH POLYURETHANE Y ULTRAVIOLET.  
SINK: POLYESTER RESIN, GEL COAT AND MINERAL FILLER.

## MAIN FEATURES

	ESPECIALE	EPECIALE CON ESPEJO	DUNAS	AMABLE/LUX/SMART	DETALLY	IDEALLY	MODERN	NEW	VETRO	SIENA	KING	ROMA	FIT	TANGO
MDP WOOD COVERED	X	X	X	X							X	X		
DRAWERS WITH TELESCOPIC SLIDERS	X	X	X		X	X	X		X					
1 YEAR GUARANTEE	X	X	X	X	X	X	X	X	X	X	X	X	X	X
MIRROR		X	X	X	X	X	X		X	X	X	X	X	X
MDF LACQUERED					X	X	X	X						
ULTRAVIOLET POLYURETHANE PAINT					X	X	X	X	X	X			X	X
POLYESTER RESIN, GEL COAT					X	X	X	X	X	X	X	X	X	X
MDP/MDF LACQUERED									X	X			X	X





# WASHBASIN

ROUND SYNTHETIC  
WASHBASIN STUDIUM  
350X350X110MM  
COD. 26156



COLOR



WHITE

RAW MATERIAL: POLYESTER RESIN, GEL COAT  
AND MINERAL FILLER.

RECTANGULAR SYNTHETIC  
WASHBASIN PALLAS  
320X360X110MM  
COD. 26157





# WASHBASIN WITH TOWEL RAIL

WASHBASIN WITH  
TOWEL RAIL FIRENZE  
595X375X130MM  
COD. 19366



COLOR



WHITE

RAW MATERIAL: POLYESTER RESIN, GEL COAT  
AND MINERAL FILLER.



**+55 62 4006.2800**

[www.sicmol.com.br](http://www.sicmol.com.br)

 /sicmol